

## **Building a Mathematical Model for the Epidemic Diseases COVID-19 and Analyzing Its Dynamical Behavior**

Maysoon M. AZIZ<sup>1</sup> & Arqam S. MAHMOOD<sup>2</sup>

### **Keywords**

Transformation of SIR model with Runge-Kutta equations, stabilization, chaotician, hopf-bifurcation.

### **Abstract**

In this paper we will focus mainly on modeling the dynamics of transmission of this virus (COVID-19) mathematically, where the classic (SIR) model as a non-linear mathematical system was used to build a mathematical model and used it with the Runge-Kutta four order (RK4) method for solving ordinary differential equations and calculating the numerical values of the disease. And comparing it with the actual real values of a particular population from the countries of the world, as well as to know the behavior of this disease in terms of stability by using many specialized mathematical methods for this purpose (the characteristic roots equation, Routh-Hurwitz criteria and Lyapunov function) and it was found that it is unstable, The binary test (0-1) was also used to test messy disease behavior and it was shown to be messy ( $K \cong 1$ ). Also we used the Poincare-hopf theorem to see the hopf bifurcation in it. The Matlab system was used to written the programs for practical application to build the model, and we took the real data for (Iraq) through the daily statistics of the number of infected with the disease in Iraq, and the comparison between the real data and the simulated data of the system were well compatible with a degree of convergence through the results, shapes and drawings that appeared to us during the application.

### **Article History**

Received  
15 Jul, 2022  
Accepted  
30 Dec, 2022

## **1. Introduction**

Mathematical modeling has emerged as a vital tool to clarify the dynamics of many infectious diseases, the most important of which is (COVID-19). It is necessary to propose model for the infectious disease as a nonlinear dynamical system while studying its properties. Often the data needed to construct a dynamic model is available through biological considerations and time-series data for disease states to fit with the test model [1]. The qualitative behavior of systems of ordinary differential equations describing differential solutions has been for a long time studied, which is an important issue. One of the models that can be used to explain the characteristics of epidemic diseases is the SIR model, which is a classic mathematical basic model that was established by (Kermack and Mckendrick) in 1927 and has been designed on a large scale. Expansions and extensions of this

<sup>1</sup> Corresponding Author. ORCID: 0000-0002-1343-6351. College of Computer Sciences and Mathematics, University of Mosul, Mosul, Iraq, [aziz\\_maysoon@uomosul.edu.iq](mailto:aziz_maysoon@uomosul.edu.iq)

<sup>2</sup> ORCID: 0000-0001-5674-789X. Directorate General of Education Nineveh, Ministry of Education, Iraq, [arqam.csp117@student.uomosul.edu.iq](mailto:arqam.csp117@student.uomosul.edu.iq)

model have been used recently to study most prevalent and endemic biological diseases [2-4].

In this paper, the equations of the SIR model are used. As a non-linear system linked to a time series and merged it with the Runge-Kutta numerical method of the fourth rank to create a mathematical system to simulate the hypothetical results of the epidemic disease that occupied the world (COVID-19) and compare it with the daily real data given according to the statistics of the world countries, and we have taken the real data of Iraq from among the countries for use in the application [5]. The degree of stability of the disease was also tested in several ways, including (the characteristic roots equation, Routh-Hurwitz criteria and Lyapunov function) all of which led that the disease is unstable [6-9], as well as the chaos was tested for the disease through the Binary test (0-1), and the result was the behavior of disease is a chaotic [10-15]. Poincare-hopf theorem has been applied to find the hopf-bifurcation of the system and with the result it haven't a hopf-bifurcation because its eigenvalues are real and not complex [16]. The Matlab program was used to write the programs required for the above-mentioned processes to identify during a time series on the behavior and developments of this disease, and we obtained the results, graphs and figures that prove the results of the solution for the theoretical side to study this disease.

This paper includes the use of the SIR model with finding its parameters to study the epidemiological situation of the disease and the use of the fourth-order Runge-Kutta numerical method with the model to generate simulation data that is used to test the chaotic disease behavior, as well as examining its stability status, and the Hopf bifurcation of the disease was also addressed. With the use of the Matlab system to write the necessary programs in the solution and obtain drawings that show the results of the solution.

## 2. SIR Model

The SIR model is a classic mathematical model devoted to studying the behavior of epidemic diseases, in which the theoretical number of people with an infectious disease in a closed population is calculated over a period of time, and it is one of the simplest biological models developed by ( Kermack-Mckendrick ) in (1927). The model contains three ordinary nonlinear time-related differential equations as follows:

### 3. Description of the SIR Model

$$\left. \begin{aligned} \dot{S} &= \frac{dS}{dt} = -\beta SI \\ \dot{I} &= \frac{dI}{dt} = \beta SI - \gamma I \\ \dot{R} &= \frac{dR}{dt} = \gamma I \end{aligned} \right\} \text{ where } \gamma, \beta \text{ are parameters}$$

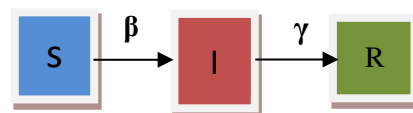

The proposed new model for SIR is as follows :

$$\left. \begin{aligned} \dot{S} &= \frac{dS}{dt} = - (0.0845) \times S \times I \\ \dot{I} &= \frac{dI}{dt} = (0.0845) \times S \times I - (0.07) \times I \\ \dot{R} &= \frac{dR}{dt} = (0.07) \times I \\ N &= S+I+R, \quad \dot{S}+\dot{I}+\dot{R} = 0 \end{aligned} \right\} \dots\dots\dots(1)$$

Where:

N: the total population of the community

S (t): the number of individuals exposed to infection during the time (t)

I (t): the number of individuals affected during the time (t)

R (t): the number of individuals recovering from disease during the time (t)

$\beta$  : is a transmission rate }  
 $\gamma$  : is recovered rate } are constant parameters of the model

where :  $\beta = \mu + \gamma$  ,  $\gamma = 1/ D$  ,  $\mu$  : is mortality rate in day , D : is duration of disease time .

The time series of real data of SIR model of COVID-19 for Iraq shown in figure 1(A).

#### 4. Basic Reproduction Number ( $R_0$ )

Definition: the basic reproduction number is represent to the average number of new infections generated by each infected person , and it is symbolized by ( $R_0$ ) , The high value of ( $R_0$ ) mean easy to transmission the disease ,and the low value of ( $R_0$ ) mean difficult to transmission the disease . ( $R_0$ ) is called too threshold of disease, ( the value of ( $R_0$ ) assumes that no pre-existing immunity, i.e it mean everyone is susceptible) , where  $R_0 = \beta / \gamma$  .

LEMMA: if  $R_0 > 1$  then I(t) is increases and the disease is epidemic, and if  $R_0 < 1$  then I(t) is decreases and the disease is endemic , It is assumed in the absence of a vaccine, the entire population will be susceptible to infection, meaning that  $S \cong N$ , so we divide  $\beta$  by N

Proof: from the SIR model we have :

$$- dI/dt = \frac{\beta}{N} SI - \gamma I \longrightarrow dI/dt = (\beta - \gamma)I \longrightarrow dI/I = (\beta - \gamma) dt$$

by integral of two hand sides :  $\ln I = (\beta I - \gamma I) + C$

$$I(t) = e^{\beta T(t) - \gamma I(t)} \cdot e^C \text{ ,, when } t = 0 \longrightarrow I(0) = e^C \longrightarrow \text{ then } I(t) = e^{\beta T(t) - \gamma I(t)} \cdot I(0)$$

$> 0$  when  $dI/dt > 0$  then  $\beta I - \gamma I > 0$

$$\beta I > \gamma I \longrightarrow \beta / \gamma > 1 \longrightarrow R_0 > 1$$

**Table 1.** Shown ( $R_0$ ) for some countries of the world from ( 1/9/2020 – 1/3/2021)

Country	Mortality	$\beta = \mu + \gamma$	$R_0$
Iraq	1.45%	0.0845	1.207
K.S.A.	1.66%	0.0866	1.237
Jordan	1.26%	0.0826	1.18
Syria	7.15%	0.1415	2.021
Turkey	0.85%	0.0785	1.1215
Iran	2.85%	0.0983	1.405
Kuwait	0.59%	0.0759	1.085
Egypt	5.87%	0.1287	1.839
India	2.10%	0.0910	1.3
UK	2.88%	0.0988	1.412
Italy	3%	0.1	1.429
German	2.41%	0.0941	1.345
U.S.A.	1.78%	0.0878	1.255

### 5. Runge-Kutta Method with 4<sup>th</sup> Order

The 4<sup>th</sup> order Runge-Kutta numerical method is one of the classic numerical methods used to solve the ordinary differential equations of nonlinear and time-related continuous dynamic systems with a number of iterations to obtain the best approximate value.

### 6. Description Method

$$y_{n+1} = y_n + h * (k_1 + 2k_2 + 2k_3 + k_4) / 6 \quad \text{where : } \Delta t = h = t_{n+1} - t_n \quad \text{and :}$$

$$k_1 = f(t_n, y_n)$$

$$k_2 = f(t_n + \frac{h}{2}, y_n + h * \frac{k_1}{2})$$

$$k_3 = f(t_n + \frac{h}{2}, y_n + h * \frac{k_2}{2})$$

$$k_4 = f(t_n + h, y_n + h * k_3)$$

From system (1) we have :  $dS/dt = f_1$  ,  $dI/dt = f_2$  ,  $dR/dt = f_3$  (  $S_0$  ,  $I_0$  ,  $R_0$  ) initial condition ,  $t_0 = 1$

$$K_1 = h * f_1(t_0, S_0, I_0, R_0)$$

$$L_1 = h * f_2(t_0, S_0, I_0, R_0)$$

$$M_1 = h * f_3(t_0, S_0, I_0, R_0)$$

$$K_2 = h * f_1(t_0 + h/2, S_0 + K_1/2, I_0 + L_1/2, R_0 + M_1/2)$$

$$L_2 = h * f_2(t_0 + h/2, S_0 + K_1/2, I_0 + L_1/2, R_0 + M_1/2)$$

$$M_2 = h * f_3(t_0 + h/2, S_0 + K_1/2, I_0 + L_1/2, R_0 + M_1/2)$$

$$K_3 = h * f_1(t_0 + h/2, S_0 + K_2/2, I_0 + L_2/2, R_0 + M_2/2)$$

$$L_3 = h * f_2(t_0 + h/2, S_0 + K_2/2, I_0 + L_2/2, R_0 + M_2/2)$$

$$M_3 = h * f_3(t_0 + h/2, S_0 + K_2/2, I_0 + L_2/2, R_0 + M_2/2)$$

$$K_4 = h * f_1(t_0 + h, S_0 + K_3, I_0 + L_3, R_0 + M_3)$$

$$L4 = h * f2(t_0 + h, S_0 + K3, I_0 + L3, R_0 + M3)$$

$$M4 = h * f3(t_0 + h, S_0 + K3, I_0 + L3, R_0 + M3)$$

$$S_1 = S_0 + h/6 * (K1 + 2K2 + 2K3 + K4)$$

$$I_1 = I_0 + h/6 * (L1 + 2L2 + 2L3 + L4)$$

$$R_1 = R_0 + h/6 * (M1 + 2M2 + 2M3 + M4)$$

The process is repeated with (n) iterations by using Matlab program . The time series of simulated data by Runge-Kutta of COVID-19 for Iraq shown in figure 1(B). From figure1(A) and (B) we notice that compatible and with a degree of closeness .

## 7. System Analysis

### 7.1. Stability of New SIR Model

There are several methods for checking the stability of the SIR model for epidemic diseases, including :

### 8. Characteristic Equation Roots

Jacobi Matrix of the System :

$$J = \begin{pmatrix} \frac{\partial \dot{S}}{\partial S} & \frac{\partial \dot{S}}{\partial I} & \frac{\partial \dot{S}}{\partial R} \\ \frac{\partial \dot{I}}{\partial S} & \frac{\partial \dot{I}}{\partial I} & \frac{\partial \dot{I}}{\partial R} \\ \frac{\partial \dot{R}}{\partial S} & \frac{\partial \dot{R}}{\partial I} & \frac{\partial \dot{R}}{\partial R} \end{pmatrix} = \begin{pmatrix} -\beta I & -\beta S & 0 \\ \beta I & (\beta S - \gamma) & 0 \\ 0 & \gamma & 0 \end{pmatrix} \Rightarrow |J - \lambda I| = \begin{vmatrix} -(\beta S + \lambda) & -\beta S & 0 \\ \beta I & (\beta S - \gamma - \lambda) & 0 \\ 0 & \gamma & 0 \end{vmatrix}$$

$$\lambda^3 + \beta I \lambda^2 - \beta S \lambda^2 + \gamma \lambda^2 + \beta I \gamma \lambda = 0 \dots\dots\dots ( 2 )$$

$$\lambda(\lambda^2 + (\beta I - \beta S + \gamma)\lambda + \beta I \gamma) = 0$$

Where :  $S = 3 \times 10^6$  ,  $I = 3500$  are initial values ,, and  $\beta = 0.0845$  ,  $\gamma = 0.07$  are parameters

$$\left. \begin{matrix} \lambda_1 = 0 , \lambda_2 = 0.0001 (+ve) \\ \lambda_3 = 253204.1799 (+ve) \end{matrix} \right\} \text{ Since the values of } \lambda \text{ are positive, the system is unstable}$$

## 9. Stability Criteria for Routh - Hurwitz

### 9.1. Stability Criteria Routh

The ROUTH table was created by the English mathematician “Edward Routh” in (1876).

### Schedule general layout ROUTH

$S_n$	$a_n$	$a_{n-2}$	$a_{n-4}$	.....
$S_{n-1}$	$a_{n-1}$	$a_{n-3}$	$a_{n-5}$	.....
$S_{n-2}$	$b_1$	$b_2$	$b_3$	.....
$S_{n-3}$	$c_1$	$c_2$	$c_3$	.....
:	$d_1$	$d_2$	$d_3$	.....
$S_0$	....	....	....	....

Where :  $b_i = \frac{a_{n-1} \cdot a_{n-2i} - a_n \cdot a_{n-(2i+1)}}{a_{n-1}}$  ,  $c_i = \frac{b_1 \cdot a_{n-(2i+1)} - a_{n-1} \cdot b_{i+1}}{b_1}$

If there are tag variable elements in the first row in the ROUTH table, the system will be unstable.

Using the characteristic equation (2)

$$(\lambda^3 + (\beta I - \beta S + \gamma)\lambda^2 + \beta I \gamma \lambda = 0$$

Where  $a_0 = 0$  ,  $a_1 = \beta I \gamma$  ,  $a_2 = (\beta I - \beta S + \gamma)$  ,  $a_3 = 1$

$$b_1 = \frac{a_2 \cdot a_1 - a_3 \cdot a_0}{a_2} = a_1 - \frac{a_3 \cdot a_0}{a_2} = \beta I \gamma - \frac{1 \cdot 0}{\beta I - \beta S + \gamma} = \beta I \gamma > 0$$

$$b_2 = \frac{a_1 \cdot a_4 - a_5 \cdot a_0}{a_1} = \frac{0 - 0}{\beta I \gamma} = 0 , c_1 = \frac{b_1 \cdot a_0 - a_2 \cdot b_2}{b_1} = 0$$

$S^3$	$a_3$	$a_1$	0	0	$S^3$	1	$24.5 \times 10^{-4}$	0
$S^2$	$a_2$	$a_0$	0	0	$S^2$	-253204	0	0
$S^1$	$b_1$	$b_2$	0		$S^1$	20.70	0	0
$S^0$	$c_1$	$c_2$	0		$S^0$	0	0	0

Since there is a negative component in the first column of the Routh table and other positive elements the system is unstable.

### 10. Hurwitz Stability Criteria

The Hurwitz Matrix : And created by the German mathematician Adolf Hurwitz in 1895.

$$H = \begin{vmatrix} a_1 & a_3 & a_5 & \dots & 0 & 0 & 0 \\ a_0 & a_2 & a_4 & \dots & 0 & : & : \\ 0 & a_1 & a_3 & \dots & 0 & : & : \\ 0 & a_0 & a_2 & \dots & 0 & 0 & : \\ : & 0 & a_1 & \dots & a_n & : & : \\ : & : & a_0 & \dots & a_{n-1} & 0 & : \\ : & : & & & & & : \\ : & : & 0 & \dots & a_{n-2} & a_n & \\ : & : & & \dots & a_{n-3} & a_{n-1} & : \\ 0 & 0 & 0 & \dots & a_{n-4} & a_{n-2} & a_n \end{vmatrix}$$

$$a_0 = 0, a_1 = 20.70, a_2 = -253204.1799, a_3 = 1$$

That the real polynomial (P) is:

$$\Delta_1(p) = |a_1| = > 0, \quad \Delta_2(p) = \begin{vmatrix} a_1 & a_3 \\ a_0 & a_2 \end{vmatrix} = > 0, \quad \Delta_3(p) = \begin{vmatrix} a_1 & a_3 & a_5 \\ a_0 & a_2 & a_4 \\ 0 & a_1 & a_3 \end{vmatrix} > 0$$

$\Delta_k(p)$ : called Hurwitz determinants

Note: For the system to be stable, all Hurwitz specifiers must be positive. Through the characteristic of equation (2):

$$\Delta_1(p) = |a_1| = |20.70| = 20.70 > 0 \text{ (+ ve)}$$

$$H(P) = \begin{vmatrix} 20.70 & 1 & 0 \\ 0 & -253204 & 0 \\ 0 & 20.7 & 1 \end{vmatrix} \Rightarrow \Delta_2(p) = \begin{vmatrix} a_1 & a_3 \\ a_0 & a_2 \end{vmatrix} = \begin{vmatrix} 20.70 & 1 \\ 0 & -253204.18 \end{vmatrix} =$$

$$= -5241326.5 < 0 \text{ (- ve)}$$

$$\Delta_3(p) = \begin{vmatrix} a_1 & a_3 & a_5 \\ a_0 & a_2 & a_4 \\ 0 & a_1 & a_3 \end{vmatrix} = \begin{vmatrix} 20.70 & 1 & 0 \\ 0 & -253204 & 0 \\ 0 & 20.7 & 1 \end{vmatrix}$$

$$= 20.7 \times 253204.18 \times 1 = -5241326.5 < 0 \text{ (Negative)}, \text{ so the system is unstable.}$$

## 11. Lyapunov Function

$$V(S, I, R) = \frac{1}{2} (S^2 + I^2 + R^2)$$

$$\frac{dv}{dt} = \dot{V}(S(t), I(t), R(t)) = S\dot{S} + I\dot{I} + R\dot{R}$$

$$\dot{V} = S \times (-\beta I \gamma) + I \times (\beta S I - \gamma I) + R \times (\gamma I)$$

By initial values and parameters we obtain on :

$$\dot{V} = > 0 \text{ (positive)} \quad \text{Then the system is unstable .}$$

## 12. Binary (0-1) Test of Chaos

The scales that can be observed are:

$$q_n = \sum_{k=1}^n \phi(k) \sin(kc) \quad , \quad P_n = \sum_{k=1}^n \phi(k) \cos(kc)$$

where :  $c \in (0, \pi)$  ,  $n = 1, 2, 3, \dots, L$  ) from the behavior of  $(P_n \ \& \ q_n)$  the mean square of the displacement can be calculated  $(MSD) = M(n)$

$$M(n) = \lim_{L \rightarrow \infty} \left( \frac{1}{L} \sum_{k=1}^L [(P(k+n) - P(k))^2 + (q_n(k+n) - q_n(k))^2] \right)$$

Where :  $n = 1, 2, \dots, L/10$

$$Vosc(n) = [E(\Phi)]^2 \times \frac{1 - \cos(nc)}{1 - \cos(c)} \quad , \quad E(\Phi) = \lim_{L \rightarrow \infty} \left( \frac{1}{L} \sum_{k=1}^L \phi(k) \right)$$

$$So : D(n) = M(n) - Vosc(n)$$

$$K_{corr} = K_c = \lim_{n \rightarrow \infty} \frac{\log M(n)}{\log(n)}$$

**Kc cases :** If the value of  $K_c \cong 0$  then indicates that the dynamic system is regular (not chaotic) and its movement is a turos (annular movement) .

And if the value of  $K_c \cong 1$  then indicates that the dynamic system is a chaotic nad it is moving as Brownian motion .By using program written in Mat lab system we get on  $K_c = 0.912 \cong 1$ , in this case the behavior of the dynamic disease in (Iraq ) is chaotic .

## 13. HOPF Bifurcation

By PoinCare Andronov HOPF theorem we have :

The disease is epidemic and  $R_0 > 1$  , then it has one equilibrium point :

$$Eq.(S^*, I^*, R^*) = (N, 0, 0)$$

$$\therefore N = S + I + R \quad \longrightarrow \quad N = S + 0 + 0 \quad \longrightarrow \quad \therefore N = S$$

$$J = \begin{vmatrix} \frac{\partial S}{\partial S} & \frac{\partial S}{\partial I} & \frac{\partial S}{\partial R} \\ \frac{\partial I}{\partial S} & \frac{\partial I}{\partial I} & \frac{\partial I}{\partial R} \\ \frac{\partial R}{\partial S} & \frac{\partial R}{\partial I} & \frac{\partial R}{\partial R} \end{vmatrix} = \begin{vmatrix} -\beta I & -\beta S & 0 \\ \beta I & (\beta S - \gamma) & 0 \\ 0 & \gamma & 0 \end{vmatrix} \quad \Longrightarrow \quad \therefore J_{p(N,0,0)} = \begin{vmatrix} 0 & -\beta N & 0 \\ 0 & (\beta N - \gamma) & 0 \\ 0 & \gamma & 0 \end{vmatrix} \quad , \text{ eigenvalue :-}$$



$$\Rightarrow \begin{vmatrix} -\lambda & -\beta N & 0 \\ 0 & (\beta N - \gamma - \lambda) & 0 \\ 0 & \gamma & -\lambda \end{vmatrix} \Rightarrow \lambda^3 - \beta n \lambda^2 + \gamma \lambda^2 = 0 \rightarrow \lambda^2(\lambda - (\beta n - \gamma)) = 0$$

either :  $\lambda^2 = 0 \rightarrow \lambda_1 = \lambda_2 = 0$

or :  $\lambda - (\beta n - \gamma) = 0 \rightarrow \lambda_3 = \beta N - \gamma$

By initial values and values of parameters we get on :  $\lambda_3 = 253499.93 > 0$   
(+ve value)

By applying the (Poin-Care Andronov Hopf) theorem to the dynamic system, we found the SIR system of disease does not have a Hopf bifurcation because its eigenvalues are real values and not complex and that the system has only a limit cycle.

### 14. Graphical Analysis

**Figure 1(A).** show simulated data of SIR model susceptible, infected and recovered of disease in Iraq

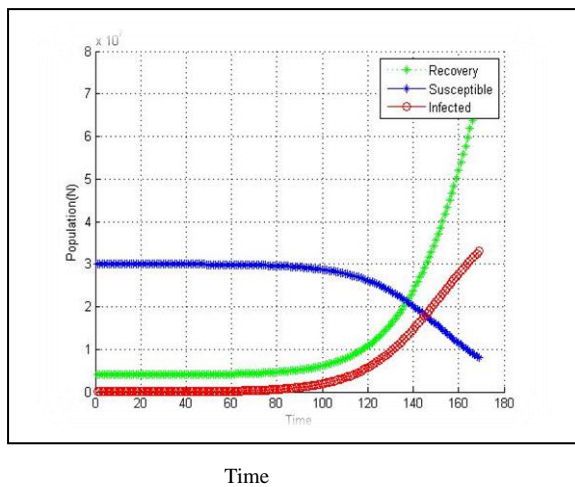

**Figure1 (B)** .show real data of SIR model susceptible, infected and recovered of disease in Iraq

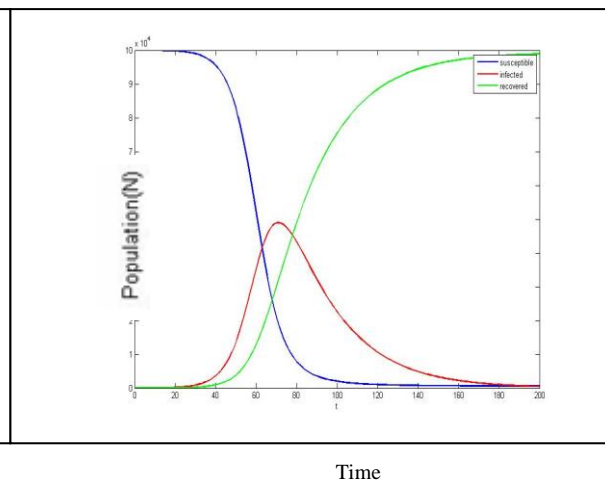

**Figure2(A).** show a chaotic of simulated data of Iraq (a):  $\log(M)$  versus  $\log(t)$  , (b):  $M$  versus  $t$  , (c):  $(k)$  versus  $(c)$  , (d) :  $(p)$  versus  $(q)$

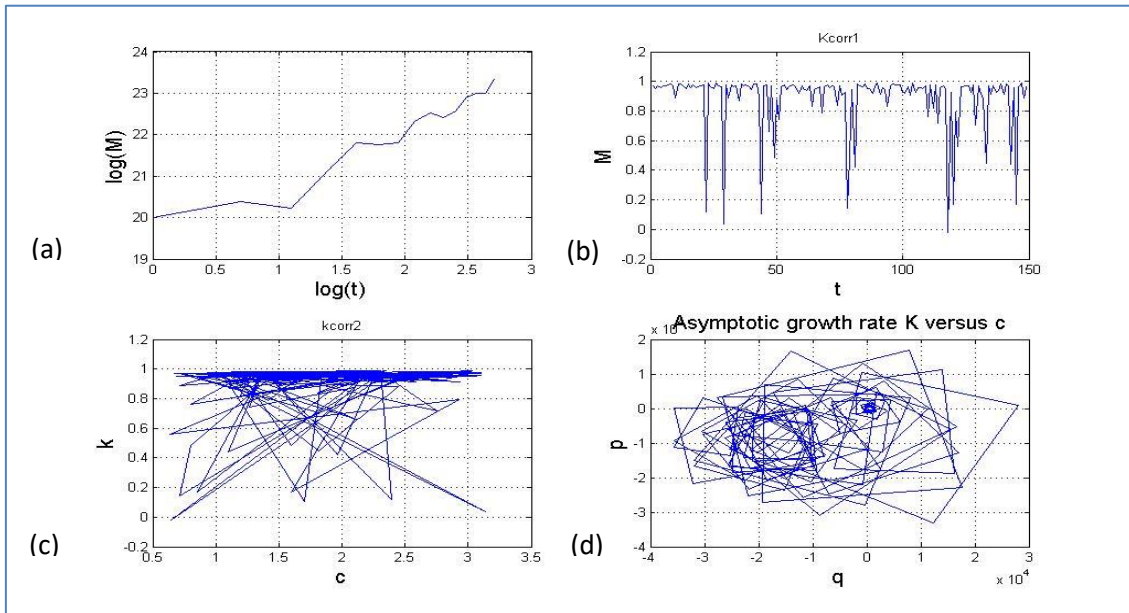

**Figure2(B).** show a chaotic of simulated data of Iraq (a):  $\log(M)$  versus  $\log(t)$  , (b):  $(M)$  versus  $(t)$  , (c):  $(k)$  versus  $(c)$  , (d) :  $(p)$  versus  $(q)$

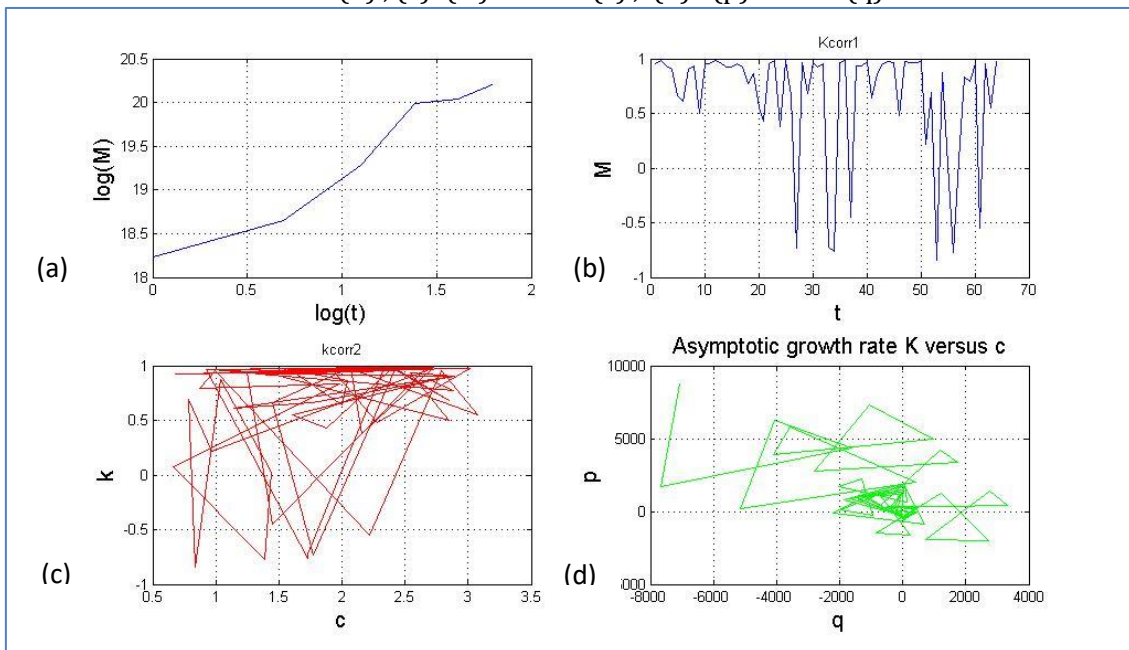

**Figure3 (a)** : series time with Infected of real data of Iraq

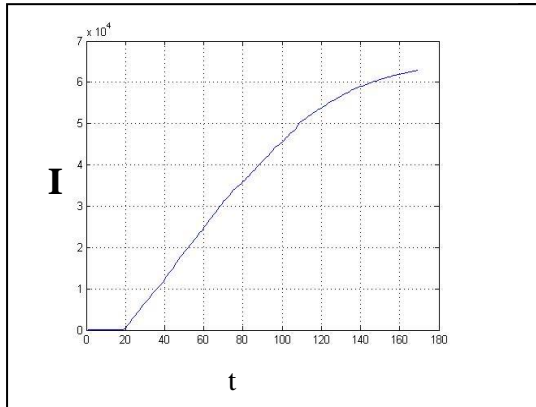

**Figure3 (b)** : series time with Infected of simulated data of Iraq

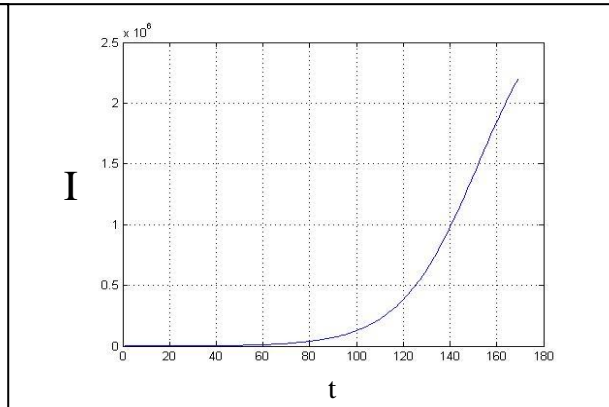

**Figure4.**Shown limit cycle of the SIR system

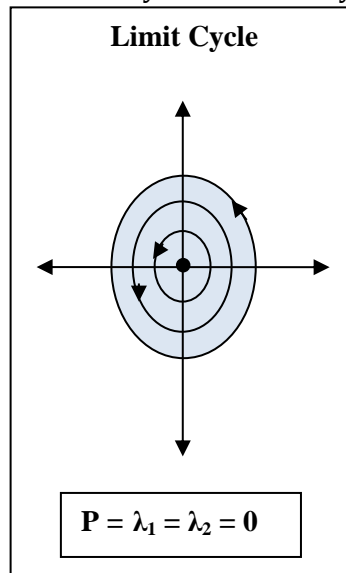

## 15. Conclusion

In this paper, the SIR model was built and the Runge-Kutta numerical method was determined from the fourth order, and we transformed the method with the new proposed model and used this transformation to solve non-linear problems related to the time series in which time is a main factor to determine its behavior and nature and obtain simulation data after giving initial values for the disease ( COVID-19 ). We have proved in Lemma that  $dI / dt > 0$ , and from this it was proved that  $R_0 = \beta/\gamma > 1$ , which means that the disease (covid-19) is epidemic and prevalent. So from the real data that we got through the daily statistics for (covid-19) in (Iraq) and the simulation data (virtual) resulting from the conversion application. The real and simulated data we are tested in terms of stability in several mathematical methods, including ( the characteristic roots equation, the Routh-Hurwitz criteria, and the Lyapunov function) and it appeared that to be unstable. The binary test (1-0) was also used to diagnose the chaotic and the behavior of disease was found to be chaotic, as the Kcorr value was close to one, (K

corr = 0.912), the Hopf-Bifurcation was studied for the dynamic system of the disease and it was found that it does not have a Hopf-Bifurcation because its eigenvalues are real and not complex. the programs written in Matlab were used in all the above mentioned processes to obtain the results, numbers and drawings that illustrate The behavior and dynamics of the disease in Iraq and the strong effect on the population during the time period (240 days).

### Acknowledgements

The authors are very grateful to the University of Mosul / College of Computer Sciences and Mathematics for their provided facilities, which helped to improve the quality of this work.

### References

1. Herbert W. Hethcote, The basic epidemiology models: models , expression for  $R_0$ , parameter estimation, and applications. Mathematical Understanding of Infectious Disease Dynamics, World Scientific Publishing Co. Pte. Ltd, (2008), vol.61
2. Howard (Howie) Weiss, The SIR model and the Foundations of Public Health , MATerials MATemàtics journal Publicació electrònica de divulgació del Departament de Matemàtiques de la Universitat Autònoma de Barcelona,Volum 2013, treball no. 3, 17, pp. 17
3. Bootan Rahman, Imad A. Aziz, Fuad W. Khdhr, Dler FD Mahmood, Preliminary Estimation of the Basic Reproduction Number of SARS-CoV-2 in the Middle East, – Published online: 1 May 2020) vol.13 .
4. Dilip Kumar Bagal, Arati Rath, Abhishek Barua, and Dulu Patnaik ,Estimating the parameters of susceptible-infected-recovered model of COVID-19 cases in India during lockdown periods, Chaos, Solitons & Fractals, ELSEVIER, vol. 34, November 2020 .
5. Md. Tareque Hossaina, Md. Musa Miahb, Md. Babul Hossainc, Numerical study of Kermack-Mckendrik SIR model to predict the outbreak of Ebola virus diseases using Euler and fourth order Runge-Kutta methods, American Scientific Research Journal for Engineering, Technology, and Sciences (ASRJETS), Volume 37, No 1, pp 1-21, 2017
6. ECE 680 Modern Automatic Control, Routh's Stability Criterion ,vol. 6 , June 13, 2007.
7. Maysoon M. Aziz, Dalya M. Merie, Stability and chaos with mathematical control of 4-d dynamical system, Indonesian Journal of Electrical Engineering and Computer Science, Vol. 20, No. 3, December 2020, pp. 1242~1251
8. Korobeinikov, Andrei, LYAPUNOV functions and global stability for SIR and SIRS epidemiological models with non-linear transmission, Hokkaido University Collection of Scholarly and Academic Papers : HUSCAP, Bulletin of Mathematical Biology, 68(3), (2006) , pp. 615-626 .

9. Georg A. Gottwald and Ian Melbourne , The (0-1) test for chaos : A review, school of mathematics & statistics,, the university of Sydney; 2016 Sydney NSW, Australia , pp.221-247.
10. Loukas Zachilas and Iacovos N. Psarianos, Examining the chaotic behavior in dynamical systems by means of the (0-1) test, Hindawi Publishing Corporation Journal of Applied Mathematics,vol. 14, 2012 .
11. Georg A. Gottwald , Ian Melbourne , On the Implementation of the 0–1 Test for Chaos, SIAM Journal on Applied Dynamical Systems, No. 8 (2009), pp. 129-145
12. Maysoon Aziz, Muhammad Hamid, The Possibility of Increasing The Predictability Indices After Control of 3D-Continuous-Time System, International Conference on Computing and Information Science and Technology and Their Applications (ICCISTA), Vol. 5, September 2019
13. Maysoon M. Aziz, Mansour N. faraj, Numerical and Chaotic Analysis of CHUA'S CIRCUIT, Journal of Emerging Trends in Computing and Information Sciences, Vol. 9, NO. 5, May 2012 .
14. R. Gopal, A. Venkatesan, and M. Lakshmanan, Applicability of 0-1 test for strange nonchaotic attractors , AIP Publishing ,Vol. 16 , 5 June 2013 .
15. Maysoon M. Aziz, Mansour N. Faraj, Diffculty of predicting earthquakes in MOSUL DAM , International Journal of Technical Research and Applications , Volume 3, Issue 6 (November-December, 2015), PP. 29-36 .
16. Hong Yang , Stability and Hopf bifurcation for a logistic SIR model with a stage – Structure, International Journal of Biomathematics , Vol. 9, No. 1 (2016) 1650013 (22 pages) .

© Copyright of Journal of Current Researches on Educational Studies is the property of Strategic Research Academy and its content may not be copied or emailed to multiple sites or posted to a listserv without the copyright holder's express written permission. However, users may print, download, or email articles for individual use.